

RINGO / WEST

RIN 180.. WS 180..

RIN 980.. WS 980..

RIN 184.. WS 184..

RIN 185.. WS 185..

RIN 285.. WS 285..

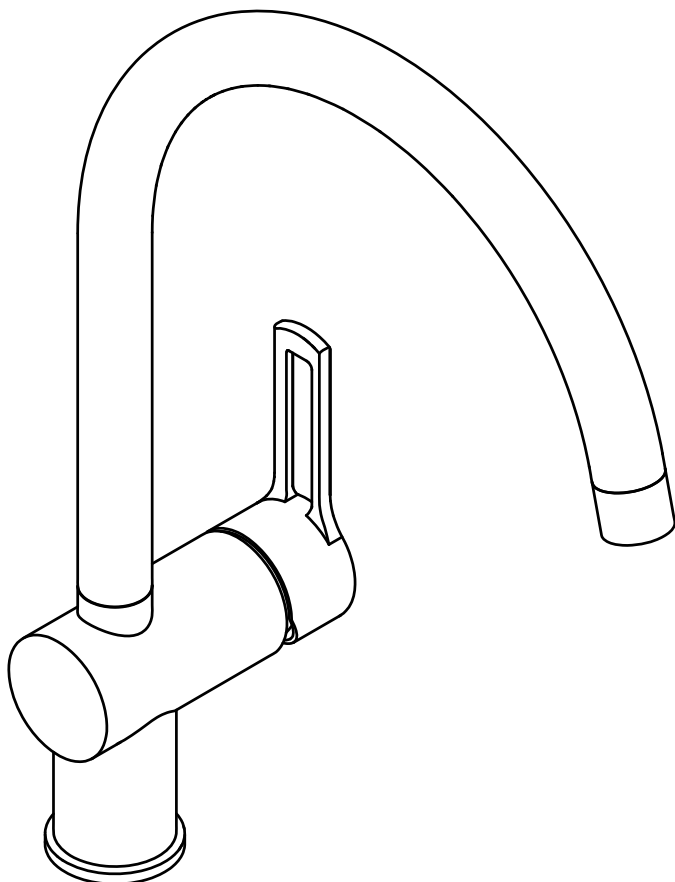

1

Montaggio Assembly

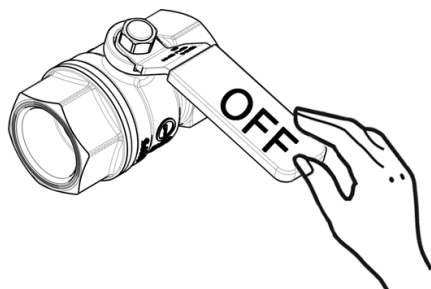

$65 \pm 5^{\circ}\text{C}$



$15 \pm 5^{\circ}\text{C}$

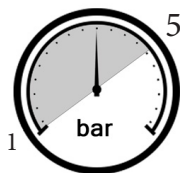

MIN - MAX

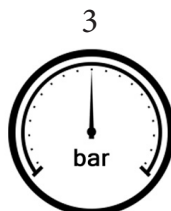

OK

2 a

180 980 184 185 285

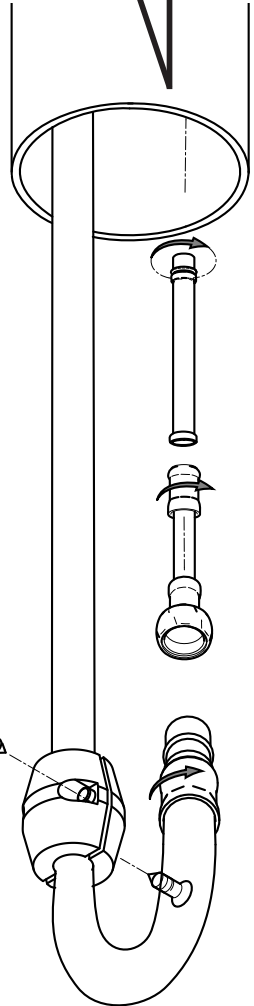
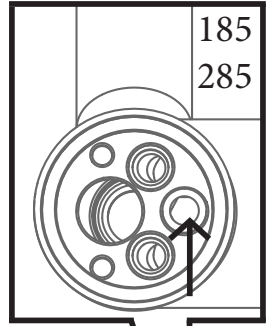
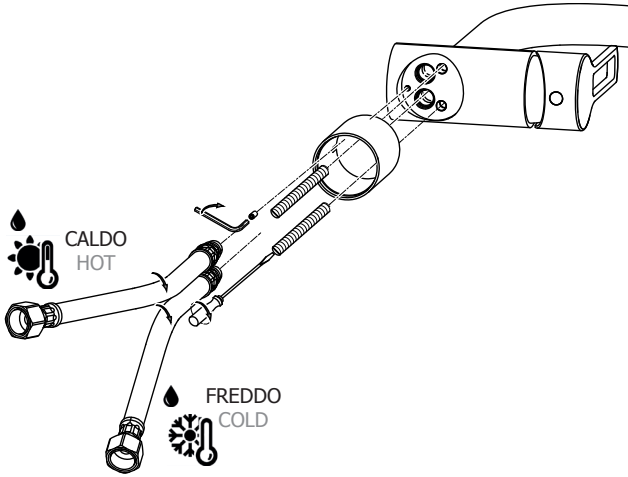

b

184

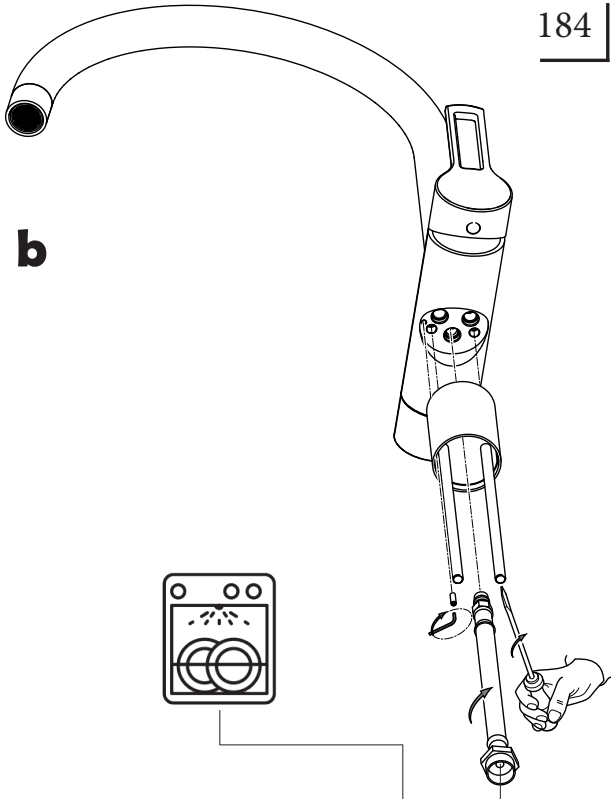

C

180 980 184 185 285

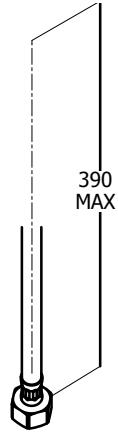
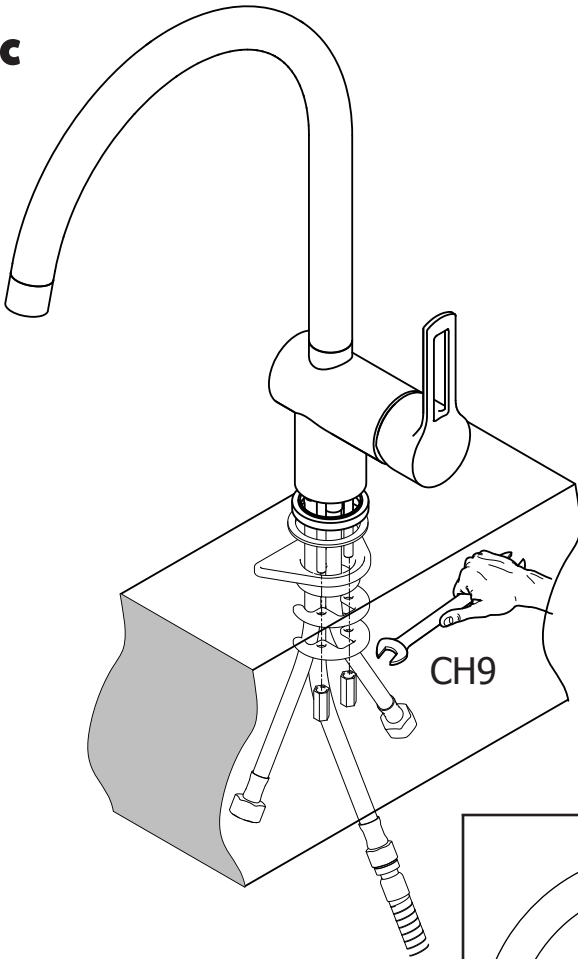

G 3/8"

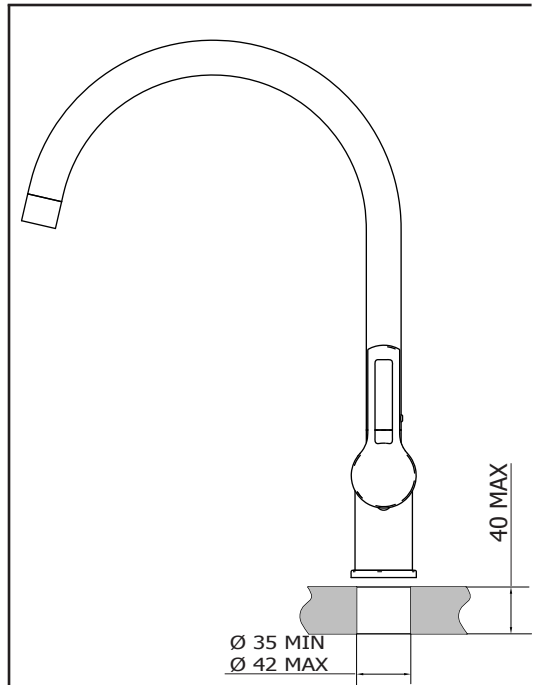

40 MAX

Ø 35 MIN
Ø 42 MAX

Funzionamento
Working

185 285

285

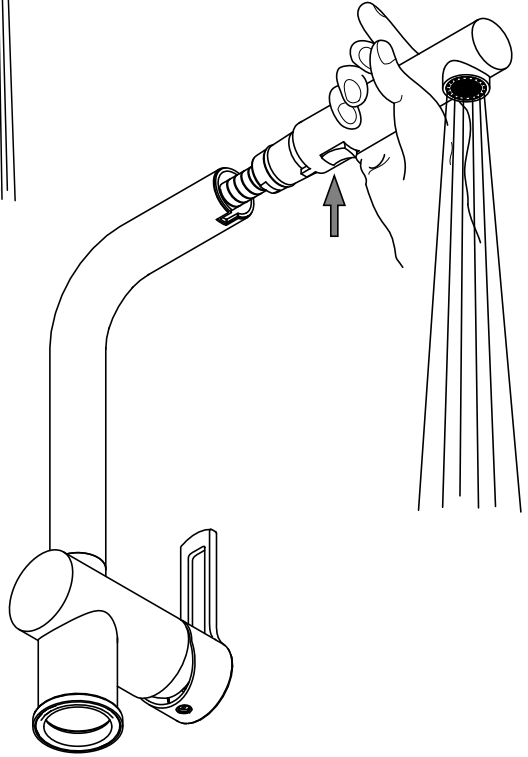
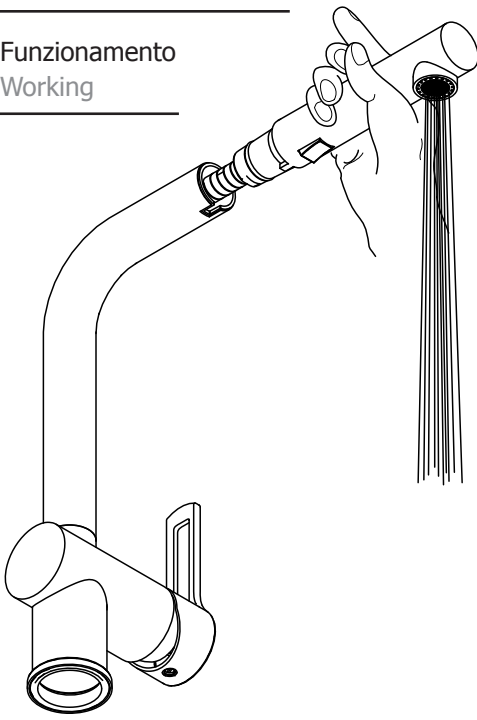

180
980
184

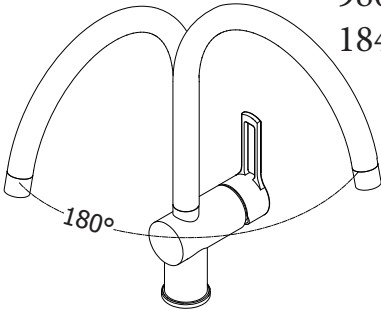

185
285

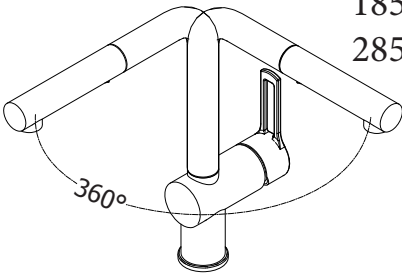

M

Manutenzione
Service

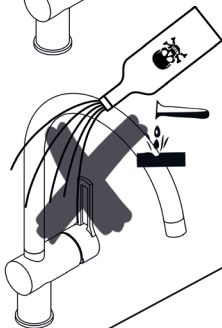
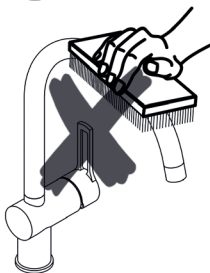
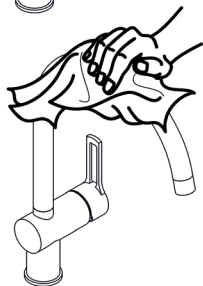
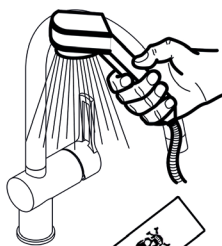
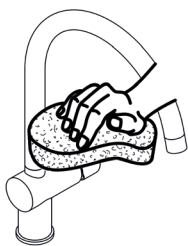
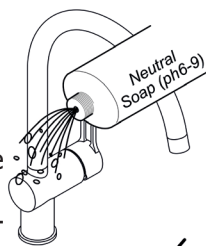

S

Sostituzione Cartuccia
How to replace Cartridge

a

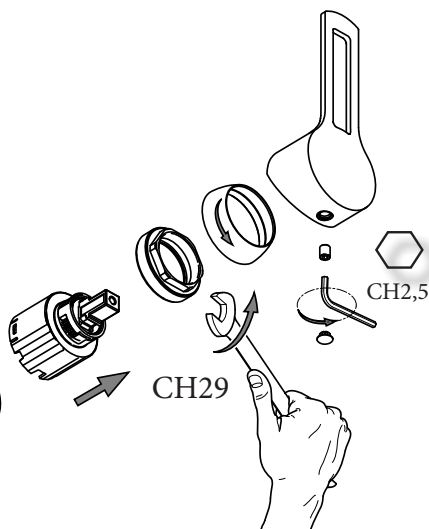
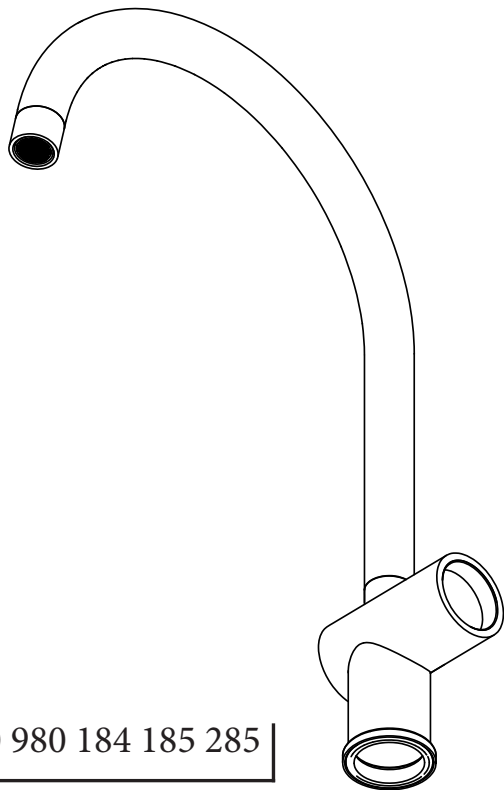

180 980 184 185 285

Sostituzione Aeratore
How to replace Aerator

180 980 184 185 285

b

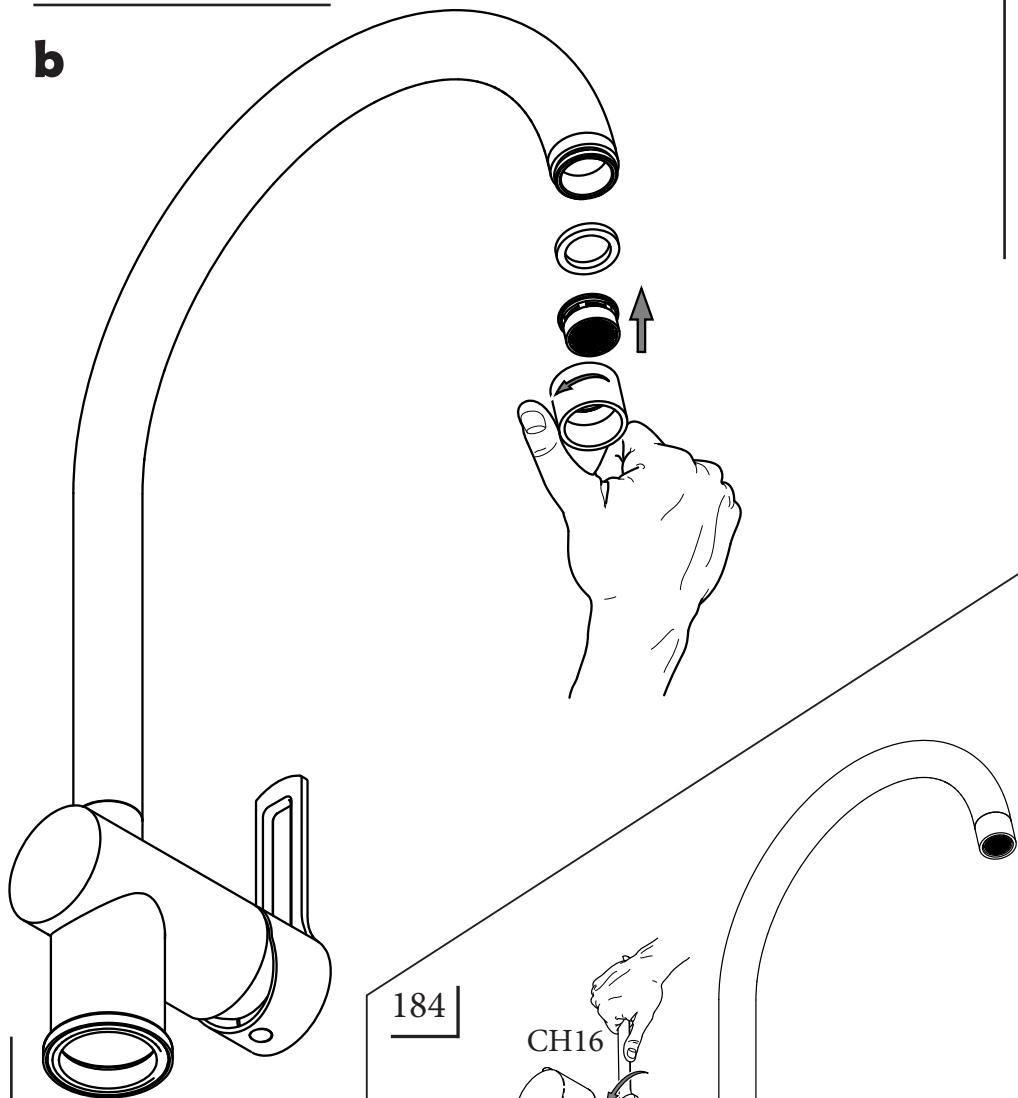

184

c

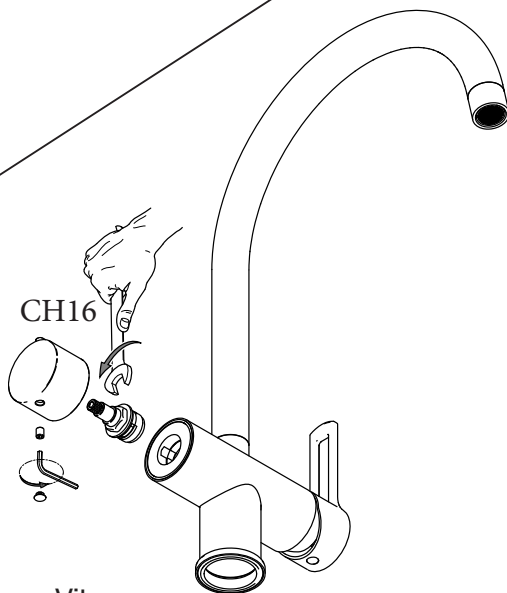

Sostituzione Vitone
How to replace Ceramic Disc Valve

Sostituzione Flex Nylon e Doccetta
How to replace Flex Nylon and Hand Shower

185
285

d

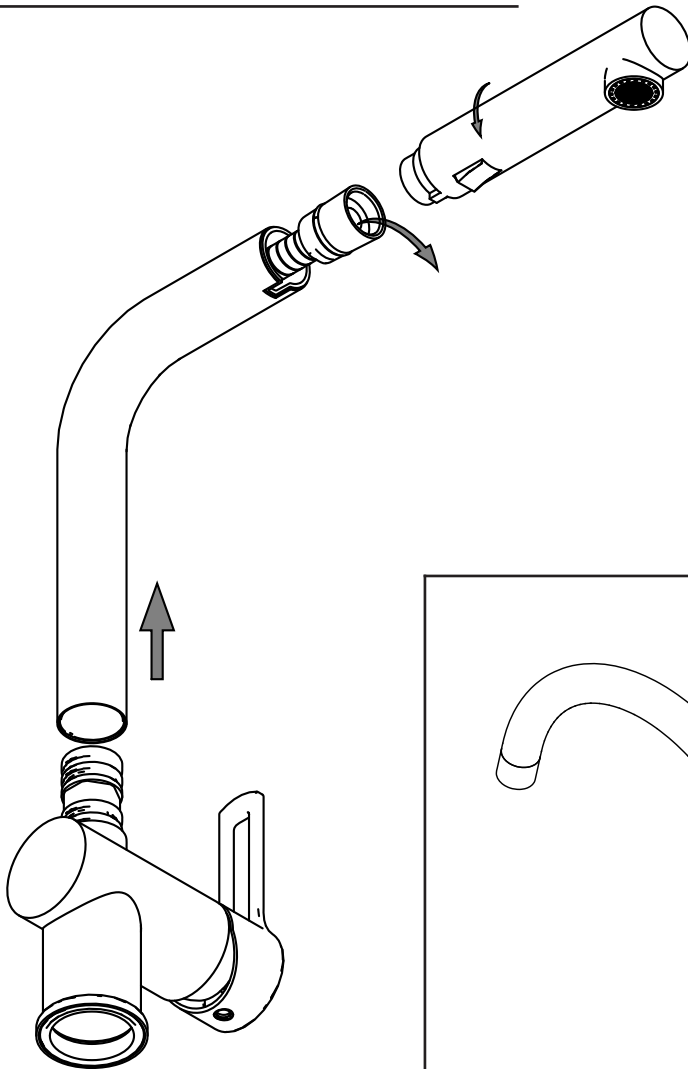

180
980
184

e

Sostituzione Canna
How to replace Spout

